



ANALYTICAL SCIENCE

- Siedziba Australii
- Producent akcesoriów:

- ❖ GC
- ❖ GC-MS
- ❖ LC
- ❖ LC-MS





- strzykawki

- septy

- linery

- ferrulki

- kolumny kapilarne

- detektory / fotopowielacze

Strzykawkki – GC . LC

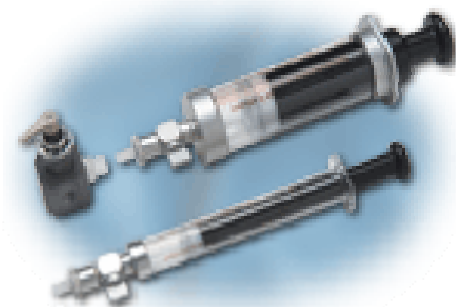
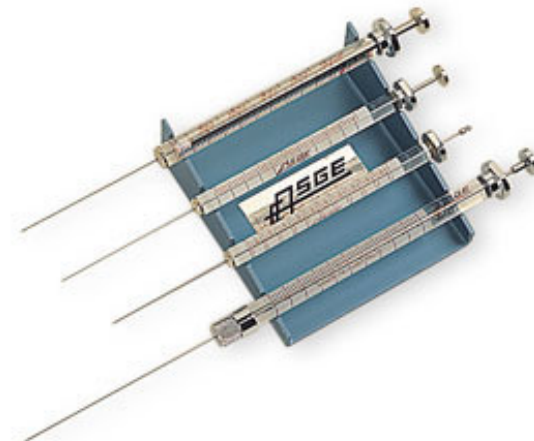
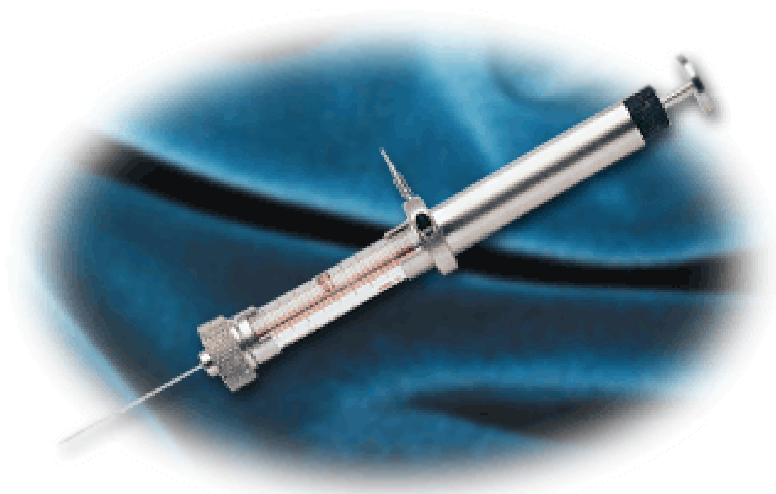

Kolumny – GC, LC

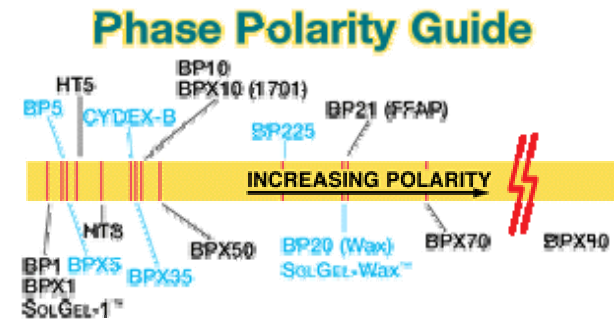

Łączniki

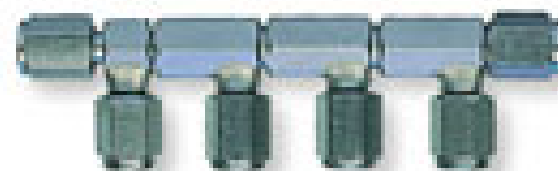
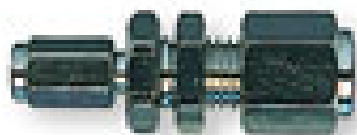
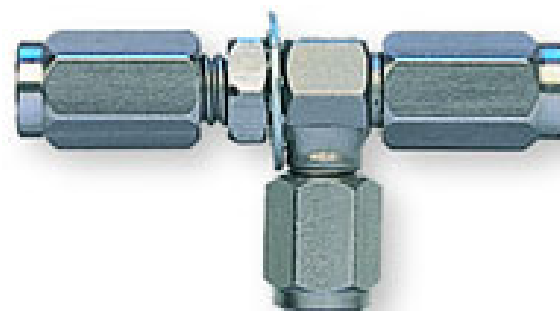
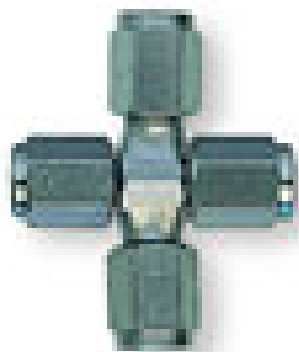

Aksesoria

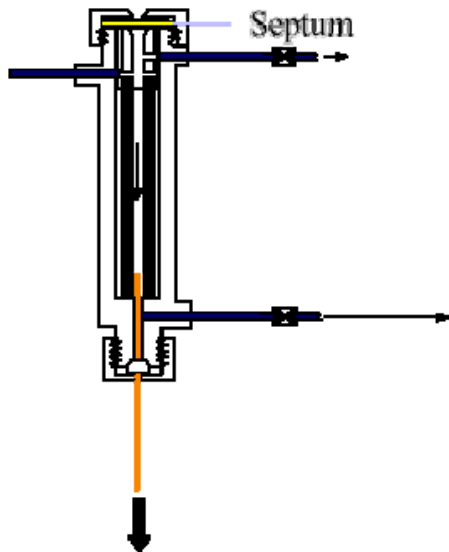

Detektory MS

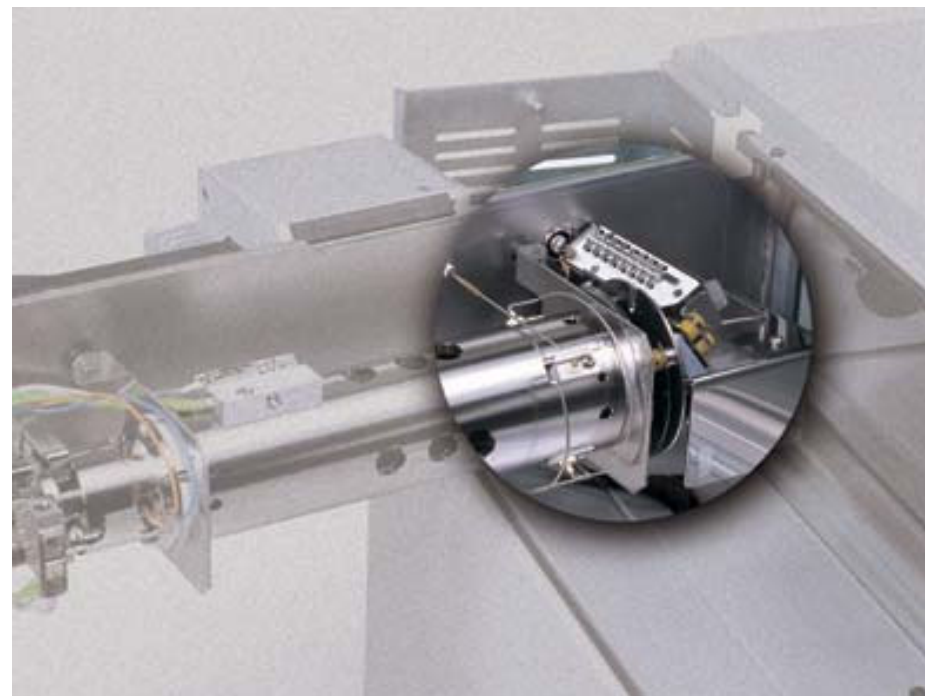

ALC 12 ALCOHOLS

Analysis of Branched Alcohols on Thick Film BPX35 with ms-NoVent™

Phase: BPX35, 1.0µm film
Sample: Neat Solvents
Column: 30m x 0.25 mm ID
Initial Temp: 40°C, 5 min.
Rate 1: 10°C/min to 230°C,
Final Temp: 230°C, 5 min.
Detector Type: Mass Spectrometer
Carrier Gas: He, 28.2 psi
Carrier Gas Flow: 1.8 mL/min.
Constant Flow: On
Average Linear Velocity: 30 cm/sec at 40°C
Injection Mode: Split
Split Ratio: 180:1
Injection Volume: 0.1 µL
Injection Temperature: 250°C
Autosampler: No
Liner Type: Split/Splitless Focus Liner
Liner Part Number: 092017
Column Part Number: 054704
ms-NoVent™ Part no.: 113400
HP5973 restrictor: 113409
Full Scan / SIM: Full scan 20-450

- Components**
1. Methanol
 2. Ethanol
 3. *isopropyl* alcohol
 4. *t*-Butyl alcohol
 5. *isobutyl* alcohol
 6. 2-Methoxyethanol
 7. *n*-Butanol
 8. 2-Ethoxyethanol
 9. Ethylene glycol
 10. Propylene glycol
 11. Diethylene glycol
 12. Triethylene glycol

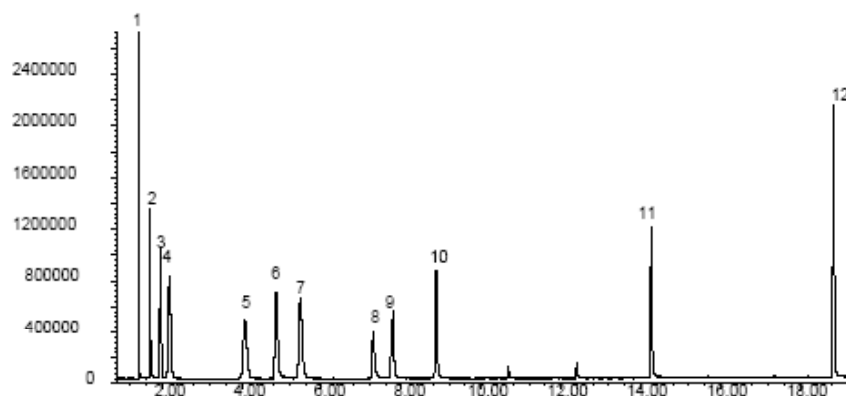

visit www.sge.com or contact our technical Customer Support Team on: techsupport@sge.com

SGE International Pty. Ltd.
email:support@sge.com

SGE Incorporated (USA)
email:usa@sge.com

SGE (France) Sarl
email:france@sge.com

SGE Deutschland GmbH
email:germany@sge.com

SGE Japan Inc.
email:sgejpn@ijitn.jp

SGE Australia Pty. Ltd.
email:sales@sge.com

SGE Europe Ltd. (UK)
email:uk@sge.com

SGE (Italia) Srl
email:sge.italia@tin.it

SGE China Service Centre
email:sge@bj.col.com.cn

SGE India
email:sgeindia@bom4.vsnl.net.in